



# ASPECT

*The Aspect of your life!*





## About MK

Honeywell Electrical Devices & Systems India Ltd., is a part of Honeywell's Automation and Control Solutions (ACS) which comprises of six business units employing 50,000 people in over 100 countries. In India the company is over two decades old and has revolutionised the electrical industry by introducing the concept of modularity and cable management systems. Honeywell Electrical Devices & Systems India Ltd.'s leading wiring accessories brand is MK.

MK has been delivering electrical connectivity and safety since 1919 and is the world's foremost manufacturer of electrical and data connectivity products and solutions. A pioneer in the field with several innovations to its credit, MK has established a reputation for the highest standards in quality, safety and reliability.

With over 6000 products in the portfolio, MK meets every aspect of electrical installation from a simple plug to a highly sophisticated cable management system.





## MK Aspect

Look at any great design, and what you'll always see is careful attention to detail. The fact is that items like switches and sockets really count - and the better designed and made they are, the more of a difference they will make.

New MK aspect is a beautiful new range of switches and sockets, which is innovative and unusual in a number of ways- some visible, some not. The design is visibly very simple and very stylish. Its slim profile and flawless front plate ensures that it always looks extra special. Less visible, but just as important, are the high quality materials they are made from, the functionality, reliability and safety, which have made MK electrical products famous.







Brushed Stainless Steel

### The Style Aspect

The simple, clean styling of MK Aspect is both classic and contemporary and looks at home anywhere, in almost any kind of environment where style and quality are important. The profile is just 4mm slim making it discrete, yet so stylish. The concealed screws and high quality finish makes it elegant and really stunning.







Polished Brass



### The Beauty Aspect

MK Aspect is beautifully designed and superbly made. It comes in a choice of seven high quality finishes, brushed stainless steel, polished chrome, polished brass, charcoal, champagne, satin chrome and white. All have the same slim and flawless frontplates - which are easy to fit and come complete with matching rockers.

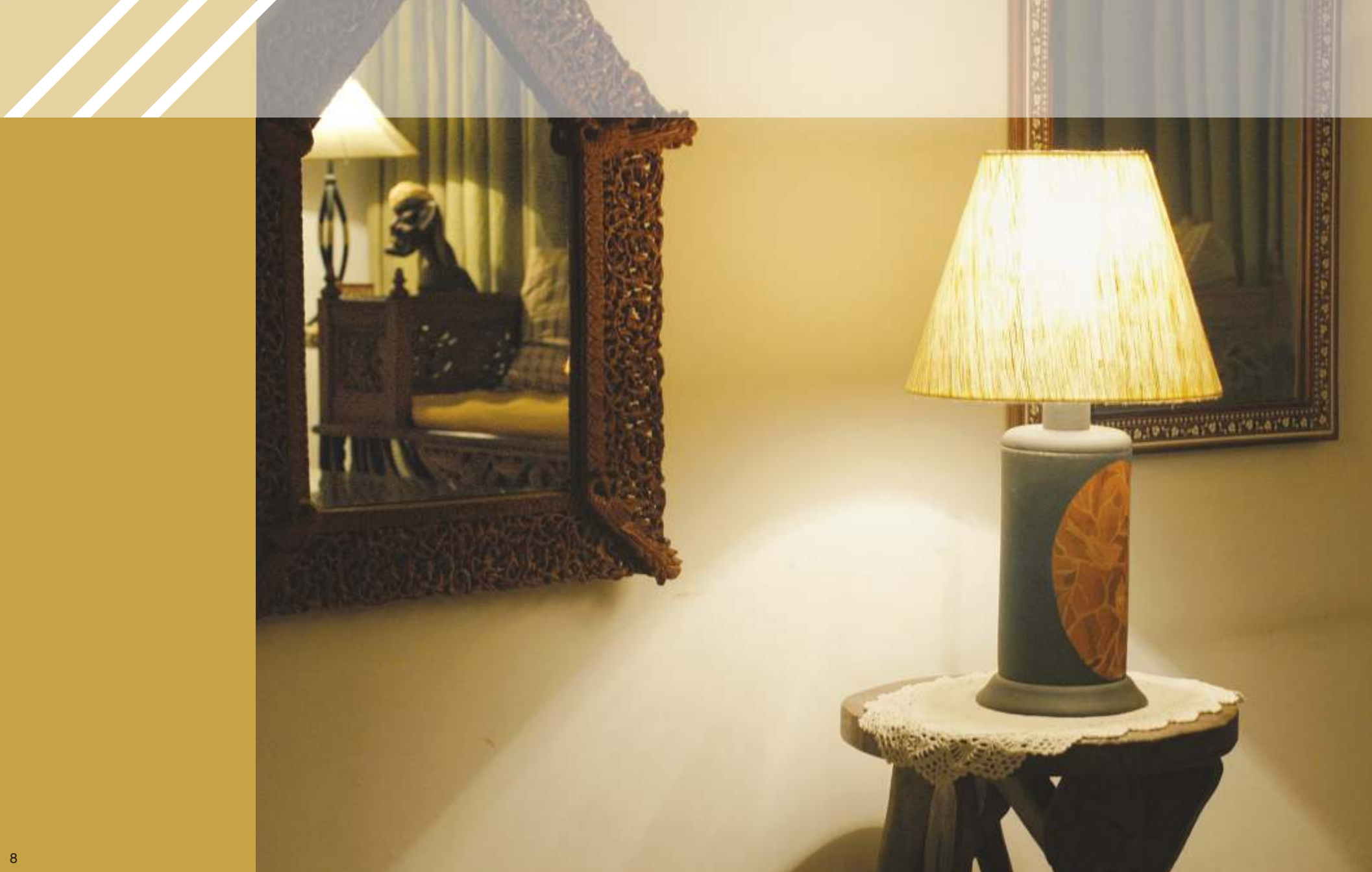



Charcoal

### The Optional Aspect

As well as a wide choice of finishes, the new MK Aspect offers a comprehensive range. There are all kinds of switches and sockets, a range of outlets for TV, IT and telecom services. There are reliable and effective dimmer switches, and modular switches - all simple to install. All the options you could want.





### The Choice Aspect

MK is committed to offering as wide a choice as possible with all its products and MK Aspect is no exception. In addition to grid plates of up to 8 module with all the relevant options and accessories and a choice of two standard finishes - brushed steel and polished brass and five more special finishes\* viz white, charcoal, polished chrome, champagne and satin chrome, no other range is as flexible.

*\* - lead time to service order 8 to 10 weeks*



Polished Chrome





### The Durability Aspect

In both materials and manufacture, MK Aspect switches and sockets are extremely robust, durable and reliable. Our brass-finished products, for example, are subject to a unique finishing process, which makes them resistant to corrosion and discoloration. It is quality and features like this which make us more than comfortable to give Aspect an exclusive 20-year guarantee.







## The Safety Aspect

MK is renowned for the exceptional safety of its products. All sockets, for instance, have a unique 3-pin safety shutters, allowing access to the supply only when all 3 pins of a standard plug are in place; double pole switching ensures that all contacts are disconnected from the supply for extra safety; sockets have dual earth terminals for High Integrity Earthing applications - and what's more all MK products are tested to exceed British Standard requirements.



Champagne

## Aspect Features

- Aspect is a classy metallic range of switches, sockets and accessories with a variety of finishes to choose from.
- Being ultra slim and with a highly polished or brushed finish they are sure to be an attraction on the wall
- Just 4mm thick!- Flushes with the wall
- Clipping on and removing the front plate from the grid is pretty simple and user-friendly
- Plastic gaskets are provided to overcome shortcomings in wall finishes (plastering unevenness)
- Corrosion resistant surface treated metal grid
- Patented spring clip design- Ensures positive earth connection of the frontplate and end user safety
- Terminal screws are backed out and captive terminals are upwards facing to make installation easier
- Funnel entrance to terminals – doesn't cut wire strands; ensures positive contact
- Clear markings for easy identification

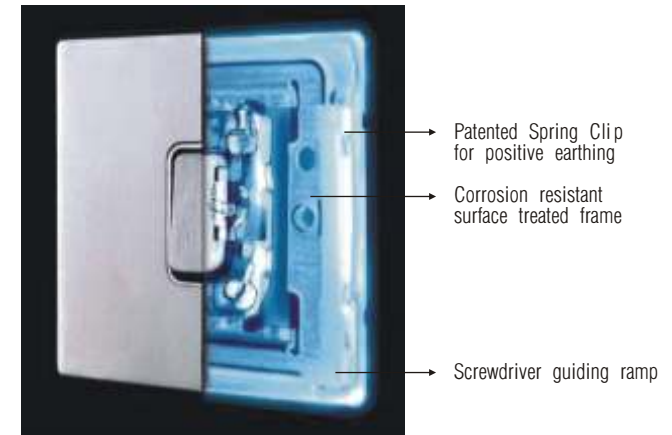

## Aspect Technical

### Installation

The MK 'Aspect' range of products consists of the main product complete with its support frame and clipping medium, plus a separate front plate. The product is mounted to the wall, after wiring, and the front plate clipped onto the frame.

Note: When installing Aspect do not over tighten screws, so as to prevent damage or distortion to the product or support frame

### Front-Plate Installation

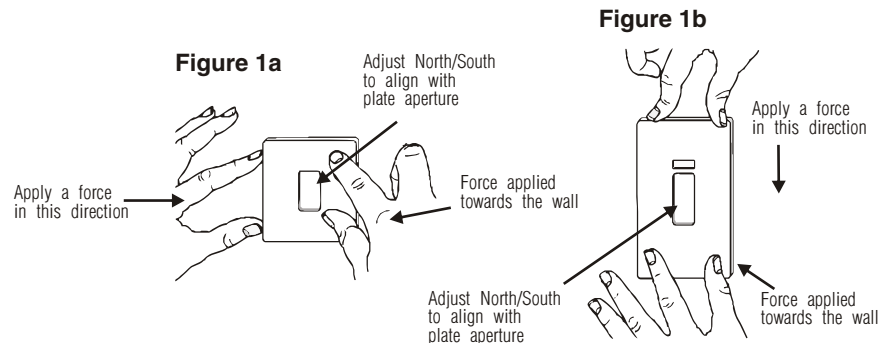

### Front-Plate Removal

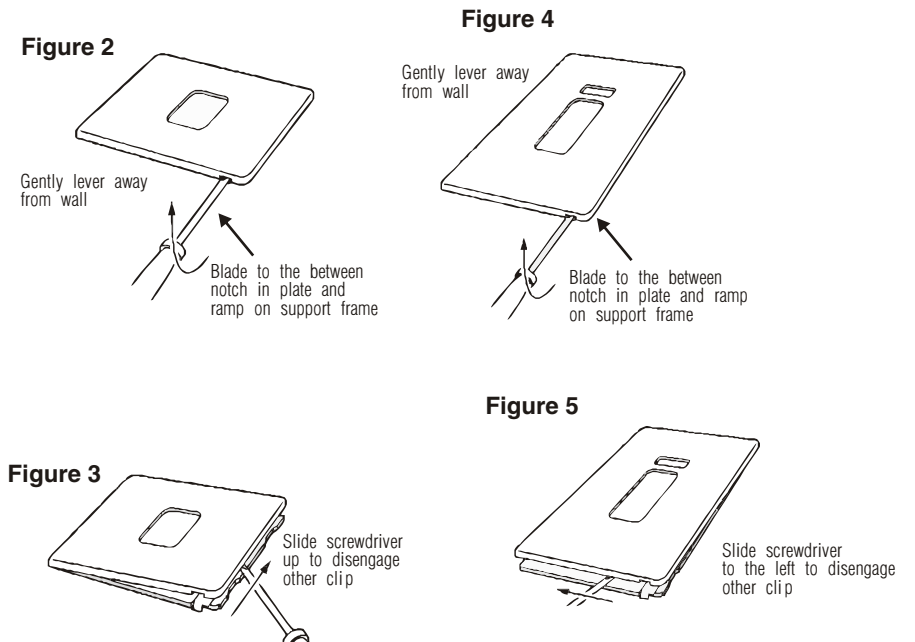

## Round Pin Socket Outlets

### Standards and approvals

Round pin socket outlet comply with BS 546: 1950

#### TECHNICAL SPECIFICATION

##### Electrical

Voltage rating	: 250V a.c.
Terminal capacities	:
5 amp sockets (K24381)	: 3 x 2.5mm <sup>2</sup> 2 x 6mm <sup>2</sup> (stranded)
15 amp sockets (K24383)	: 3 x 2.5mm <sup>2</sup> 3 x 4mm <sup>2</sup> 2 x 6mm <sup>2</sup>

##### Physical

Ambient operating temperature	: -5°C to +40°C (not to exceed an average of more than 25°C in any 24 hour period)
IP rating	: IP2XD
Max. installation altitude	: 2000 metres

### Installation

Aspect socket outlets can be wall or bench mounted - do not mount or use as a trailing socket or where they may be subjected to excessive moisture or dampness.

### Cable management

Aspect socket outlet can be mounted in a variety of MK trunking systems.



### Description

A range of round pin socket outlet designed for ease of installation and having all the advantages and design features of the Aspect range. These products can be quickly installed as replacements for existing socket outlets or in new installations.

### Dimensions (mm)

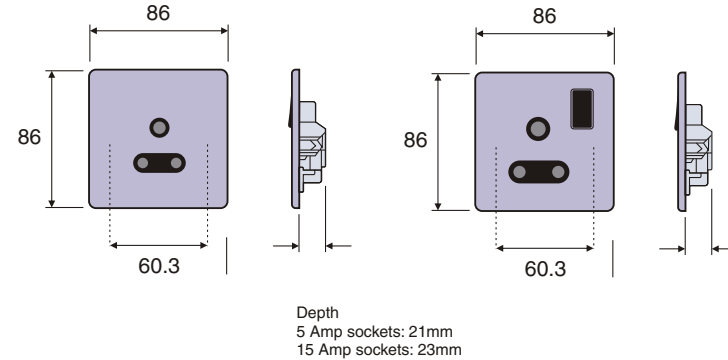

#### FEATURES

- Top access terminals make wiring easier and quicker
- 3mm switch contact gap
- Double pole switching
- Terminal screws backed out
- Additional electrical safety from neutral “make first”, “break last” feature on switched sockets
- Switch contacts with silver contact points on both surfaces for good continuity
- 5A and 15A sockets contain a 3 pin operated safety shutter
- Printed terminal markings on grey rear mouldings for clear identification

## Shaver Supply Unit

### Standards and approvals

Shaver supply units comply with BS EN 61558-2-5: 1998.

Accommodates plugs as follows:

- British 5mm dia pins on 16.6mm pitch (230V socket) to BS 4573:1970.
- European 4mm dia pins on 17 to 19mm pitch (230V socket) to IEC 83: 1975 Standard C5.
- Australian 6.5 x 1.6 flat blades each set at 30° to the vertical on a nominal pitch of 13.7mm (230V socket) AS C112:1964.
- American 6.6 x 1.6 flat horizontal blades on 12.7mm pitch (115V socket) to ANSI C73.10.

### TECHNICAL SPECIFICATION

#### Electrical

Voltage rating:

230V a.c. Input (will operate at 220-250V a.c.)

Current rating:

200mA max. (internal thermister trip current)

Maximum load : 20VA

No load voltage <275

Terminal capacities:

Each terminal will accommodate 1 x 4mm<sup>2</sup> or 2 x 2.5mm<sup>2</sup> solid conductors\*

#### Physical

Ambient operating temperature : -5°C to +40°C

IP rating:

IP41 (In Zone 2 if fixed where direct spray from showers is unlikely)

Max. installation altitude : 2000 metres

\*The design of this unit means that on no load the transformer output is allowed to be as high as 275V. This means that rechargeable shavers intended for use in the Asian continent may be damaged by the inrush current created by this higher voltage. Rechargeable shavers with a wide range of input voltage should be recharged at 115V. Shavers manufactured for the UK are designed to be used with a transformer unit. Loads in excess of 20VA may cause the solid state overload to operate before shaving is completed. This is to protect the transformer.



### Description

Designed for ease of installation and having many of the advantageous design features of the Aspect range.

May be used in bathrooms and washrooms but must only be installed in accordance with IEE Wiring Regulations BS 7671: 1992:Amendment 3.

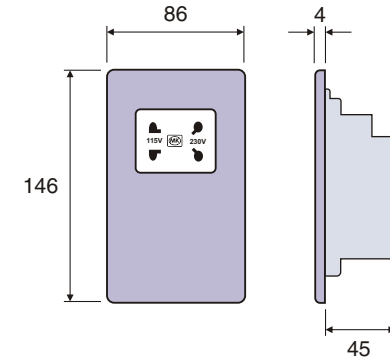

### Installation

Shaver supply unit should be wall mounted.

### Wiring

An installation instruction leaflet is available with the product packaging .

### FEATURES

- Automatic primary supply switching on insertion of plug
- Choice of 230V or 115V output socket positions
- Safety interlocked shutters to prevent insertion of two plugs simultaneously
- Only one size of screwdriver required for installation
- Printed terminal markings on grey rear mouldings for clear identification
- Integral over current device to protect transformer

## High Current Switches

### Standards and approvals

These switches comply with BS EN 60669-1:2000

#### TECHNICAL SPECIFICATION

##### Electrical

Voltage rating : 250V a.c.

Current rating : 32 A

Switch :  
3mm contact gap Double pole operation

Terminal capacity : 3 x 2.5mm<sup>2</sup>  
2 x 4mm<sup>2</sup>  
1 x 6mm<sup>2</sup>

##### Physical

Ambient operating temperature : -5°C to +40°C  
(not to exceed an average of more than 25°C in any 24 hour period)

IP rating : IP4X

Max. installation altitude: 2000 metres



### Description

A switch harmonising with the Aspect style, suitable for the switching of all domestic, commercial and industrial appliances where higher current ratings are required, i.e. cookers, heaters, commercial refrigeration units etc.

32A

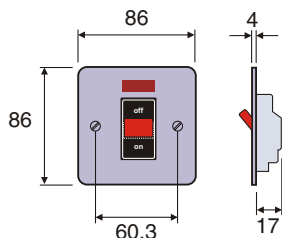

#### FEATURES

- Positive switch action
- Positive double pole switching
- Toggle action switches
- Metal frontplates
- Replaceable neon indicators

## Modular Switching System

### Standards and approvals

Switch modules

BS EN 60669-1: 2000

Accessory modules

Single non-isolated, TV/FM socket outlet,  
BS 3041: Part : 1977

Universal Socket

BS 5733: 1995

#### TECHNICAL SPECIFICATION

##### Switches

Voltage rating:  
250V a.c., 50 Hz

Current rating:  
10 or 20 amps - no derating when used on  
fluorescent or inductive loads.

Load type: No restriction

Terminal capacity:  
4 x 1mm<sup>2</sup>, 4 x 1.5mm<sup>2</sup>, 4 x 1mm<sup>2</sup>  
3 x 2.5mm<sup>2</sup>, 2 x 4mm<sup>2</sup>, 1 x 6mm<sup>2</sup>

##### Cord Outlet

Voltage rating: 250V

Current rating: 16 amps

Terminal capacity  
Supply: 2 x 4mm<sup>2</sup>  
Load: 1 x 1.5mm<sup>2</sup> multi-stand

##### Universal Socket

Voltage rating  
125/250V

Current rating: 16amps

Terminal capacity  
2 x 6mm<sup>2</sup> (stranded)  
3 x 4mm<sup>2</sup> 3 x 2.5mm<sup>2</sup>



## Modular Switching System

Frontplate Dimension (mm)

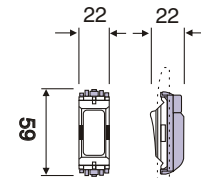
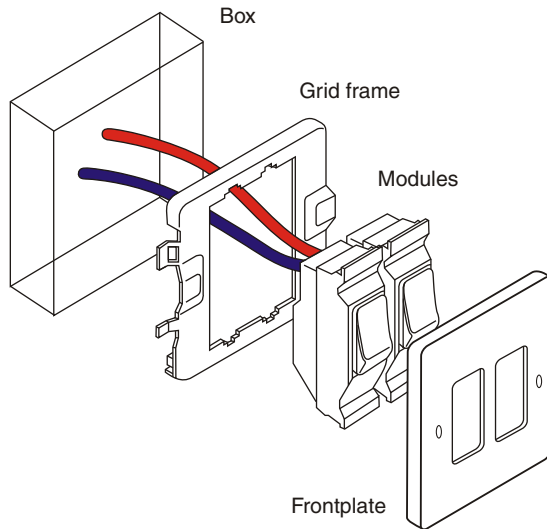
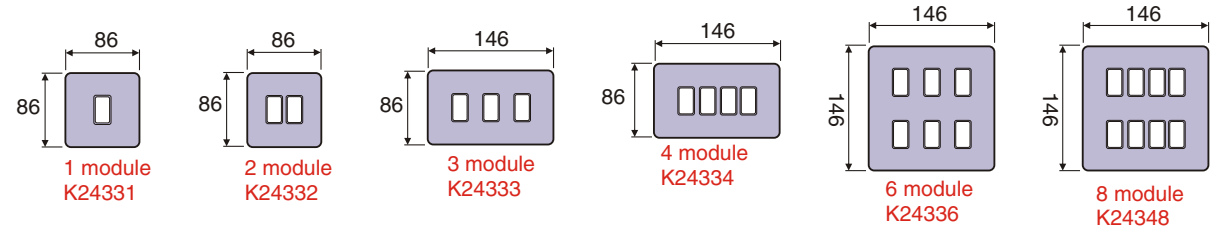

All switch and indicator modules

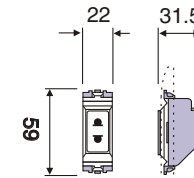

Universal Socket unit

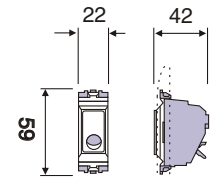

Cord unit

### Description

The system is extremely easy to assemble (see illustration) and modules can be individually changed without re-wiring of complete assembly by removal of frontplate and simply clipping in or out as required. For further installation details see 'installation' overleaf.

### Universal Socket

The Universal Socket does not incorporate an earth contact. therefore appliances needing earth connection, (class 1 equipment), must NOT be used with the socket.

The socket is intended for use with BS, USA & CEE standard plugs.

## FEATURES

- Grid modules clip fit to frame without special tools
- Modules can be removed/replaced when grid frame is fixed in position
- All products are 100% tested before delivery
- Wide variety of switch modules rated at 10 or 20 amps
- High quality grid frame
- Grid frame earth terminal has 16mm<sup>2</sup> cable capacity
- Backed out and captive terminal screws
- Plated grid frame prevents corrosion
- Top access terminal screws

# Dimmer Switches

## Standards and approvals

Dimmer switches conform to the relevant parts of BS 5518.

### TECHNICAL SPECIFICATION

#### Electrical

- Mains Supply Voltage : 220V a.c.
- Mains Supply Voltage Range : 200V a.c. to 250V a.c.
- Mains Supply Frequency : 50Hz ± 3Hz

#### Type of Loads:

Standard Dimmer:  
Fused GLS Tungsten Filament lamps only to BS EN 60064: 1996 and BS EN 60432-1 : 2000, rated at 230/240V

Warning: These dimmer switches are not suitable for use with Fluorescent Lamps or Energy Saving Lamps.

#### Physical

- Operating temperature : 0°C to + 40°C
- IP rating : IP4X
- Max. installation altitude : 2000 metres



### OVERLOAD REACTION

Case	Approximate load on the dimmer as a percentage of its maximum load	Power output to load when dimmer control is set to maximum
1	Up to 130%	Load will receive maximum power continuously.
2	>130% to 200%	Output to load will be reduced to 50% of the maximum after a delay of approximately 20 seconds after switch on.
3	>200%	Output will be disabled (load will be switched off) almost Instantaneously after switch on.

### Dimmer Switches

Dimmer switches belonging to this category conform to the safety parts of BS EN 60669-2-1.

### Dimension (mm) 1 gang single

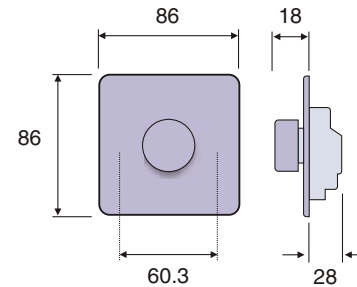



## Euro data Frontplate

**Standards and approvals**  
BS 5733

### TECHNICAL SPECIFICATION

#### Dimensions

Height	: 86mm
Width	: 86mm (1G)
Depth	: 4mm

#### Aperture Dimensions

Height	: 50mm
Width	: 50mm (1G)



#### Description

Frontplates used for mounting snapfit data modules

#### Dimensions (mm)

#### Euro Frontplates

1 gang

1 module: K24181

2 module : K24182

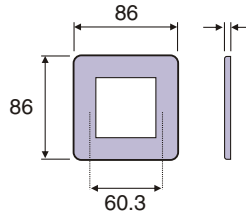

### FEATURES

- 1G and 2G frontplates
- Accept industry standard (Euro) and LJU6C snapfit modules
- 1G Euro frontplate accepts 2 Euro modules, (50 x 50mm aperture)
- 2G Euro frontplate accepts 4 Euro modules, (100 x 50mm aperture)
- ½ module (12.5 x 50mm) blank available
- Interchangeable modules clip into frontplate

## RJ45 Data Outlet

### Standards and approvals

BE EN 50173.

IEC 11801.

TIA/EIA 568A.

TIA/EIA TSB40A



### Installation

- Maximum cable length 90m.
- Do not over tighten cable ties.
- Cable bend radii, 40mm during installation, 20mm after installation.
- Do not unwind the twists in the wire pairs by more than 13mm max.
- Maximum pull force 8.7kg.

### Installation details and wiring diagram illustrations

#### TIA WIRING SCHEME COLOUR CODES:

Pin No.	568A	568B
1	WHITE / green	WHITE / orange
2	GREEN / white	ORANGE / white
3	WHITE / orange	WHITE / green
4	BLUE /white	BLUE / white
5	WHITE / blue	WHITE / blue
6	ORANGE / white	GREEN / white
7	WHITE / brown	WHITE / brown
8	BROWN / white	BROWN / white

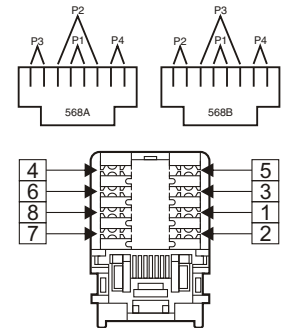

#### DIMENSIONS

Euro : 25 x 50mm

**Euro modules are to be wired as follows**

- Pair 1 - BLUE/white & WHITE/blue
- Pair 2 - ORANGE/white & WHITE/orange
- Pair 3 - GREEN/white & WHITE/green
- Pair 4 - BROWN/white & WHITE/brown

## Telephone Module - RJ11/12

### Standards and approvals

K5887 complies with FCC68.

#### TECHNICAL SPECIFICATION

##### Electrical

Cable types:

Telephone : CW1311, CW1293, CW1308, CW1316

No. of cables per termination :

Telephone: 2

RJ11/12: 1

##### Physical

Temperature range:

Ambient air - 20°C to +60°C

Max. installation altitude:

2000 metres



Wire pull-out force: 10.5 Newtons when installed correctly.

### Wiring regulation restrictions

Domestic Installations: The total REN (Ring Equivalent Number) value of all telephone equipment connected on a line must not exceed 4.

### RJ11/12 Wiring Scheme

PIN NO.	STRIPPED WIRE	COLOR	SOLID COLOUR WIRE
1	WHITE	/ green	White
2	WHITE	/ orange	Black
3	BLUE	/ white	RED
4	WHITE	/ blue	Green
5	ORANGE	/ white	Yellow
6	GREEN	/ white	Blue

Note : Main wire colour is shown in capitals

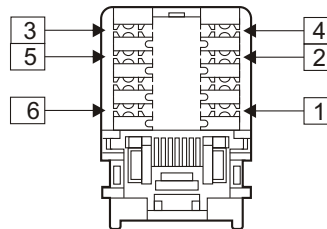

## TV Outlet

### Standards and approvals

Standards and approvals

All MK Digital TV Outlets comply with BS 5733 and BS EN 50083 where applicable.

Also IEC 169-2, BS EN 60169-2, EN 60169-24 and BS 6312 part 2

Modular products are Euro compatible.

#### TECHNICAL SPECIFICATION

##### Single Outlets

TV/FM IEC Male or Female : DC-950MHz

### Dimensions (mm)

#### Euro 1 module

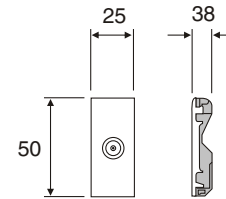

### Cable management

TV outlets can be mounted in a variety of MK trunking systems.





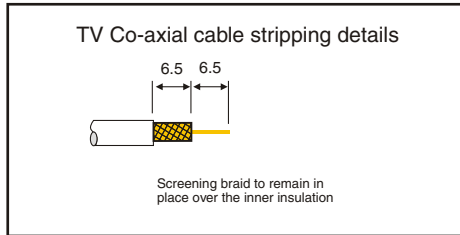
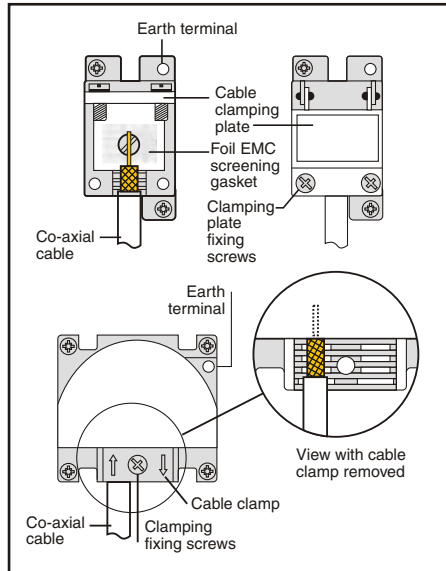



### Installation

- When installing the TV Co-axial cable ensure that all cable bends are smooth so that the inner insulation is not crushed or squashed. Otherwise the TV signal quality may be affected.
- Not suitable for loop-in loop-out installations.
- Use Ct100 cable (or equivalent.)



### FEATURES

- Non Isolated
- Fully Screened
- Earth terminal provided on TV

	Socket Outlets						Switches	
	1 GANG ROUND PIN 5 AMP	5 AMP SWITCHED SOCKET	1 GANG ROUND PIN 15 AMP SWITCHED SOCKET	16 AMP UNSWITCHED INTERNATIONAL SOCKET	16 AMP 1 MODULE UNIVERSAL SOCKET	DUAL VOLTAGE 115/230V OUTPUT 220/240V 50/60Hz INPUT	10 AMP SP 1 WAY	10 AMP SP 2 WAY
								

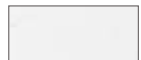

SPECIAL FINISHES

Brushed Stainless Steel	K24381 BSS W	K24382 BSS W	K24383 BSS W	SX2837 WHI	K4901 WHI	K24709 BSS W	K4881 BSS W	K4882 BSS W
Polished Brass	K24381 PBR B	K24382 PBR B	K24383 PBR B	SX2837 BLK	K4901 BLK	K24709 PBR B	K4881 PBR B	K4882 PBR B
Polished Chrome	K24381 POC B	K24382 POC B	K24383 POC B	SX2837 BLK	K4901 BLK	K24709 POC B	K4881 POC B	K4882 POC B
White	K24381 WHI W	K24382 WHI W	K24383 WHI W	SX2837 WHI	K4901 WHI	K24709 WHI W	K4881 WHI	K4882 WHI
Charcoal	K24381 CHA B	K24382 CHA B	K24383 CHA B	SX2837 BLK	K4901 BLK	K24709 CHA B	K4881 CHA B	K4882 CHA B
Lacquered Brushed Steel	K24381 LBS B	-	K24383 LBS B	SX2837 BLK	K4901 BLK	K24709 LBS B	K4881 LBS B	K4882 LBS B
Metal Box Compatibility	DW901	DW901	DW901	-	-	W26045	-	-

\* Insertion of a shaver plug automatically switches on by energising the primary side of the isolating transformer - removal automatically switches off. The transformer is protected against overload by an automatic solid state overload device with automatic resetting.

DIMENSIONS:  
146 x 86mm  
FIXING CENTRES:  
120.6mm  
BS EN 61558-2-5:1998

DIMENSIONS:  
86 x 86mm  
FIXING CENTRES:  
60.3mm  
BS.546: 1950

DIMENSIONS:  
86 x 86mm  
FIXING CENTRES:  
60.3mm  
BS.546: 1950

DIMENSIONS:  
86 x 86mm  
FIXING CENTRES:  
60.3mm  
BS.546: 1950

This socket to be installed on Euro 2 Module Front Plate.

The Universal Socket does not incorporate an earth contact. Appliance needing earth connection (class I equipment) must NOT be used with this socket. The socket is interded for use with BS, USA and CEE standard plug. BS.5733:1995

This design incorporates a double wound isolating transformer rated 20VA at 230 or 115 volts and meets BS EN 61558-2-5:1996 making is safe for use in bathrooms.\*

This switches do NOT have to be derated when used with fluorescent or inductive loads  
BS EN 60669-1: 2000

This switches do NOT have to be derated when used with fluorescent or inductive loads  
BS EN 60669-1: 2000



	Switches						Accessories	
	10 AMP 2 WAY PUSH SWITCH	10 AMP SP 2 WAY BELL PUSH SWITCH	20 AMP DP 1 WAY SWITCH	20 AMP DP 1 WAY WITH NEON	1 GANG SP 2 WAY 20 AMP WIDE ROCKER	1 GANG DP WITH NEON 32 AMP	BLANK INSERT	16 AMP CORD OUTLET

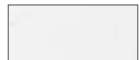

SPECIAL FINISHES

Brushed Stainless Steel	K4885 BSS W	K4885 B WHI	K4896 BSS W	K4896 N WHI	K23473 BSS W	K24305 BSS W	K4880 BSS W	K4886 WHI
Polished Brass	K4885 PBR B	K4885 B BLK	K4896 PBR B	K4896 N BLK	K23473 PBR B	K24305 PBR B	K4880 PBR B	K4886 BLK
Polished Chrome	K4885 POC B	K4885 B BLK	K4896 POC B	K4896 N BLK	K23473 POC B	K24305 POC B	K4880 POC B	K4886 BLK
White	K4885 WHI	K4885 B WHI	K4896 WHI	K4896 N WHI	K23473 WHI W	K24305 WHI W	K4880 WHI	K4886 WHI
Charcoal	K4885 CHA B	K4885 B BLK	K4896 CHA B	K4896 N BLK	K23473 CHA B	K24305 CHA B	K4880 CHA B	K4886 BLK
Champagne	K4885 LBS B	K4885 B BLK	K4896 LBS B	K4896 N BLK	-	K24305 LBS B	K4880 LBS B	K4886 BLK
Metal Box Compatibility	-	-	-	-	DW901	DW901	-	-

This switches do NOT have to be derated when used with fluorescent or inductive loads

Note: Push switches are not designed for fluorescent loads

BS EN 60669-1: 2000

This switches do NOT have to be derated when used with fluorescent or inductive loads

Note: Push switches are not designed for fluorescent loads

BS EN 60669-1: 2000

This switches do NOT have to be derated when used with fluorescent or inductive loads

BS EN 60669-1: 2000

These switches do NOT have to be derated when used with fluorescent or inductive loads.

Note: Push switches are not designed for fluorescent loads

BS EN 60669-1: 2000

This switches do NOT have to be derated when used with fluorescent or inductive loads









BS EN 60669-1: 2000

These switches do NOT have to be derated when used with fluorescent or inductive loads.

BS.3676 Pt.1 : 1989

Complete with 3 pairs of terminals. The supply terminals are suitable for up to 2 x 2.5mm<sup>2</sup> or 1 x 4mm<sup>2</sup> solid conductors. The load terminals are suitable for one 1.5mm<sup>2</sup> flexible cord.

A cord grip is also fitted.

	Modular Front Plate						Dimmer	
	1 MODULE	2 MODULE	3 MODULE	4 MODULE	6 MODULE	8 MODULE	220V a.c. 50Hz 500W SINGLE	220V a.c. 50Hz 1000W SINGLE
								

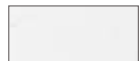

SPECIAL FINISHES

Brushed Stainless Steel	K24331 BSS	K24332 BSS	K24333 BSS	K24334 BSS	K24346 BSS	K24348 BSS	K24541 BSS	K24561 BSS
Polished Brass	K24331 PBR	K24332 PBR	K24333 PBR	K24334 PBR	K24346 PBR	K24348 PBR	K24541 PBR	K24561 PBR
Polished Chrome	K24331 POC	K24332 POC	K24333 POC	K24334 POC	K24346 POC	K24348 POC	K24541 POC	K24561 POC
White	K24331 WHI	K24332 WHI	K24333 WHI	K24334 WHI	K24346 WHI	K24348 WHI	K24541 WHI	K24561 WHI
Charcoal	K24331 CHA	K24332 CHA	K24333 CHA	K24334 CHA	K24346 CHA	K24348 CHA	K24541 CHA	K24561 CHA
Champagne	K24331 LBS	K24332 LBS	K24333 LBS	K24334 LBS	K24346 LBS	K24348 LBS	-	-
Metal Box Compatibility	DW901	DW901	W26045	W26045	W26050	W26050	DW901	DW901

DIMENSIONS:  
86 x 86mm

FIXING CENTRES:  
60.3mm

DIMENSIONS:  
86 x 86mm

FIXING CENTRES:  
60.3mm

DIMENSIONS:  
86 x 146mm

FIXING CENTRES:  
120.6mm

DIMENSIONS:  
86 x 146mm

FIXING CENTRES:  
120.6mm

DIMENSIONS:  
146 x 146mm

FIXING CENTRES:  
120.6mm

DIMENSIONS:  
146 x 146mm

FIXING CENTRES:  
120.6mm

DIMENSION: 86 x 86mm  
FIXING CENTRES: 60.3mm  
Suitable for tungsten  
GLS lamps only, with  
internal fuses.

NOT SUITABLE FOR  
FLUORESCENT LOADS.

DIMENSION: 86 x 86mm  
FIXING CENTRES: 60.3mm  
Suitable for tungsten  
GLS lamps only, with  
internal fuses.

NOT SUITABLE FOR  
FLUORESCENT LOADS.



	FSC	Volume Control	Accessories					Euro Front Plate		
	STEP FAN SPEED CONTROL 100W	SPEAKER VOLUME CONTROL	RJ 45 CAT 5E (UTP) EURO 1 MODULE	TV SINGLE IEC FEMALE EURO 1 MODULE	RJ11/RJ12 EURO 1 MODULE	EURO 1 MODULE (25x50mm) BLANK	EURO 2 MODULE (50x50mm) BLANK	EURO 1 MODULE 25 x 50mm	EURO 2 MODULE 50 x 50mm	
	Brushed Stainless Steel	K26472BSS	K26528BSS	K5845 WHI	K5851 WHI	K5887 WHI	K188 WHI	K180 WHI	K24181 BSS	K24182 BSS
	Polished Brass	K26472PBR	K26528PBR	K5845 BLK	K5851 BLK	K5887 BLK	K188 BLK	K180 WHI	K24181 PBR	K24182 PBR
	Polished Chrome	K26472POC	K26528POC	K5845 BLK	K5851 BLK	K5887 BLK	K188 BLK	K180 WHI	K24181 POC	K24182 POC
	White	K26472WHI	K26528WHI	K5845 WHI	K5851 WHI	K5887 WHI	K188 WHI	K180 WHI	K24181 WHI	K24182 WHI
	Charcoal	K26472CHA	K26528CHA	K5845 BLK	K5851 BLK	K5887 BLK	K188 BLK	K180 WHI	K24181 CHA	K24182 CHA
	Champagne	K26472LBS	K26528LBS	K5845 BLK	K5851 BLK	K5887 BLK	K188 BLK	K180 WHI	K24181 LBS	K24182 LBS
	Metal Box Compatibility	DW901	DW901	-	-	-	-	-	DW901	DW901

SPECIAL FINISHES

R J 45 Modules  
Enhanced Cat 5 performance  
Suitable for both 568A and 568B wiring schemes  
Supplied with cable tie and cable anchors to secure wires in the connectors  
TIA/EIA TSB40A: Cat 5e  
TIA/EIA 568-A: Cat 5e  
ISO/IEC/801: Cat 5e

DIMENSION  
86 x 86mm  
FIXING CENTRES  
60.3mm  
BS.5733:1995  
where applicable

DIMENSION  
86 x 86mm  
FIXING CENTRES  
60.3mm  
120.6mm  
BS.5733:1995  
where applicable

The finest architects, interior designers and engineers always recommend MK.  
Ask them. Or Contact Customer Care at [mkteam@honeywell.com](mailto:mkteam@honeywell.com) & 044-2616 1234.

## Honeywell Electrical Devices and Systems India Limited

Regd Off: 'Crescendo', 995-B, Second Avenue, Annanagar, Chennai - 600 040. India	Telephone: 091 - 44 - 66326789.
E-mail: <a href="mailto:mkteam@honeywell.com">mkteam@honeywell.com</a>	Website: <a href="http://www.mkelectricindia.com">www.mkelectricindia.com</a> Fax: 091 - 44 - 26161235.

<b>BANGALORE</b>	# 301, Prestige Kada, III Floor, # 22, Richmond Road, Bangalore - 560 025.	Telephone: 080 - 64539831/32.
	E-mail: <a href="mailto:mkbangalore@honeywell.com">mkbangalore@honeywell.com</a>	Fax: 080 - 2211 3690.
<b>CHENNAI</b>	'Crescendo', 995-B, Second Avenue, Annanagar, Chennai - 600 040.	Telephone: 091 - 44 - 66326678.
	E-mail: <a href="mailto:mkchennai@honeywell.com">mkchennai@honeywell.com</a>	Fax: 091 - 44 - 26161237.
<b>HYDERABAD</b>	Surana House, # 6-3-569/1, 4th Floor, Erramanzil 'X' Roads Khairtabad, Hyderabad - 500 082.	Telephone: 040 - 66410911.
	E-mail: <a href="mailto:mkhyderabad@honeywell.com">mkhyderabad@honeywell.com</a>	Fax: 040 - 66410930.
<b>KOCHI</b>	41/2553, 2A 2 <sup>nd</sup> Floor, Metro Palace, Opp. Town Railway Station Kochi - 682 018.	Telephone: 0484 - 2394379.
	E-mail: <a href="mailto:mkcochin@honeywell.com">mkcochin@honeywell.com</a>	Fax: 0484 - 2394732.
<b>KOLKATA</b>	Matrix Tower, DN-24, 4th Floor, Room No.403, Sector-V, Salt lake, Kolkatta - 700 091.	Telephone: 033 - 64566170.
	E-mail: <a href="mailto:mkkolkatta@honeywell.com">mkkolkatta@honeywell.com</a>	Fax: 033 - 40040962.
<b>MUMBAI</b>	Eco-elite Building, 2nd floor, Marol Maroshi Road, Marol, Next to Zakaria Indl Estate, Andheri (E), Mumbai - 400 059.	Telephone: 022 - 67650680/81.
	E-mail: <a href="mailto:mkmumbai@honeywell.com">mkmumbai@honeywell.com</a>	Fax: 022 - 67650682.
<b>NEW DELHI</b>	Plot No. 2-A, Corner Market, Malviya Nagar, New Delhi – 110 017.	Telephone: 011 - 64737433.
	E-mail: <a href="mailto:mkdelhi@honeywell.com">mkdelhi@honeywell.com</a>	Fax: 011 - 26673102.

